

# The Defender 6' Tall Surface Mount

www.maldenmetals.ca  
info@maldenmetals.ca

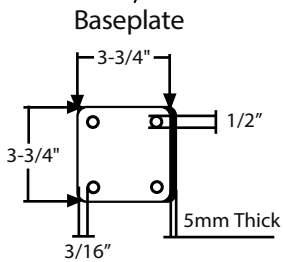

## Side View

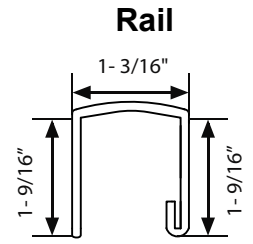
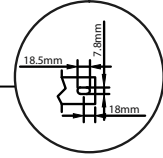
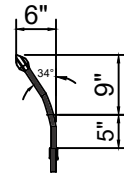
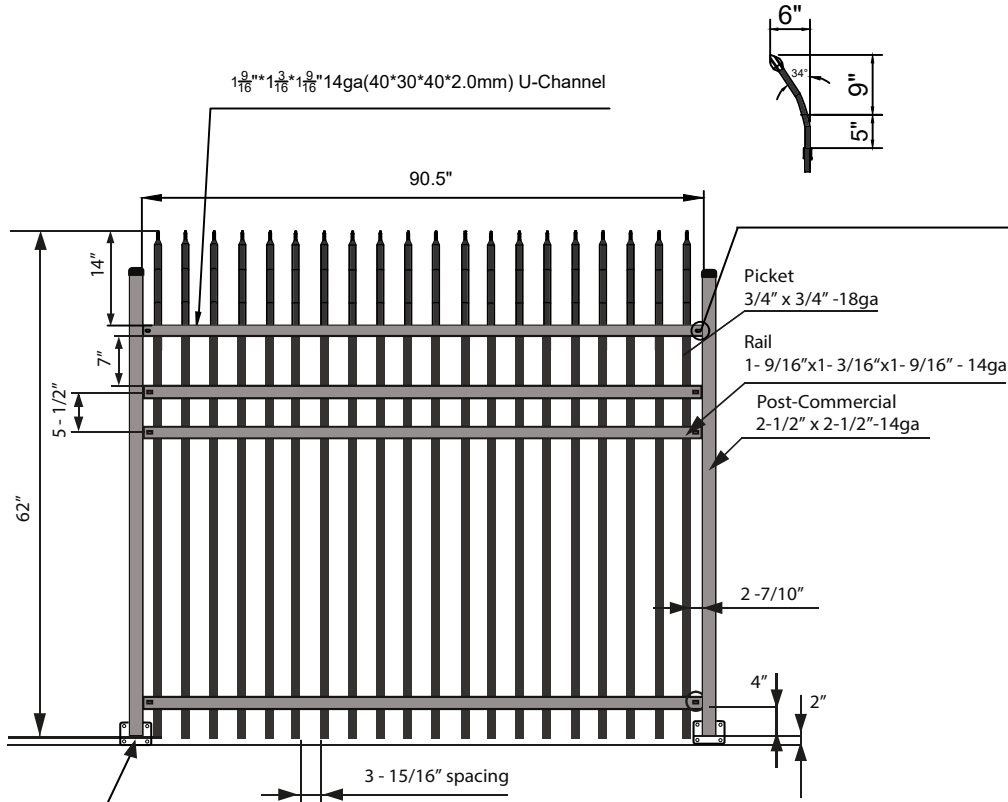

### NOTES:

1. Commercial use 2-1/2" posts.
2. Post Spacing - 2-1/2" post 93-1/2" C/C.

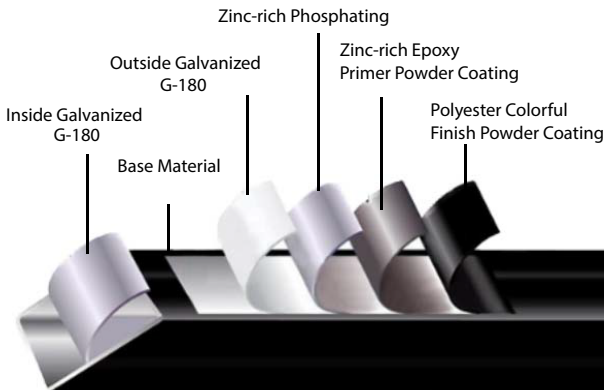
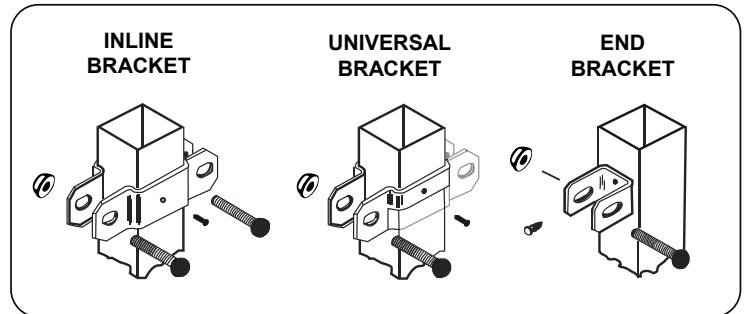

STEEL PROTECTION SYSTEM